





Panel Mount Antenna

-  TETRA 800MHz
-  Public Safety
-  Omni Directional
-  ROHS Compliant
-  Vehicle Mount

EBF-S5

- Stylish design
- Detachable whip for carwash
- Moulded cable option



The 'Euro' base panel mount (EBF) has a smooth profile which is free from protrusions. The flexible whip detaches from base cup, ideal for car washing.

The Euro Base antenna range is available with a moulded cable option, just change the part number beginning from 'EBF' to 'EBMF'



Technical Drawing

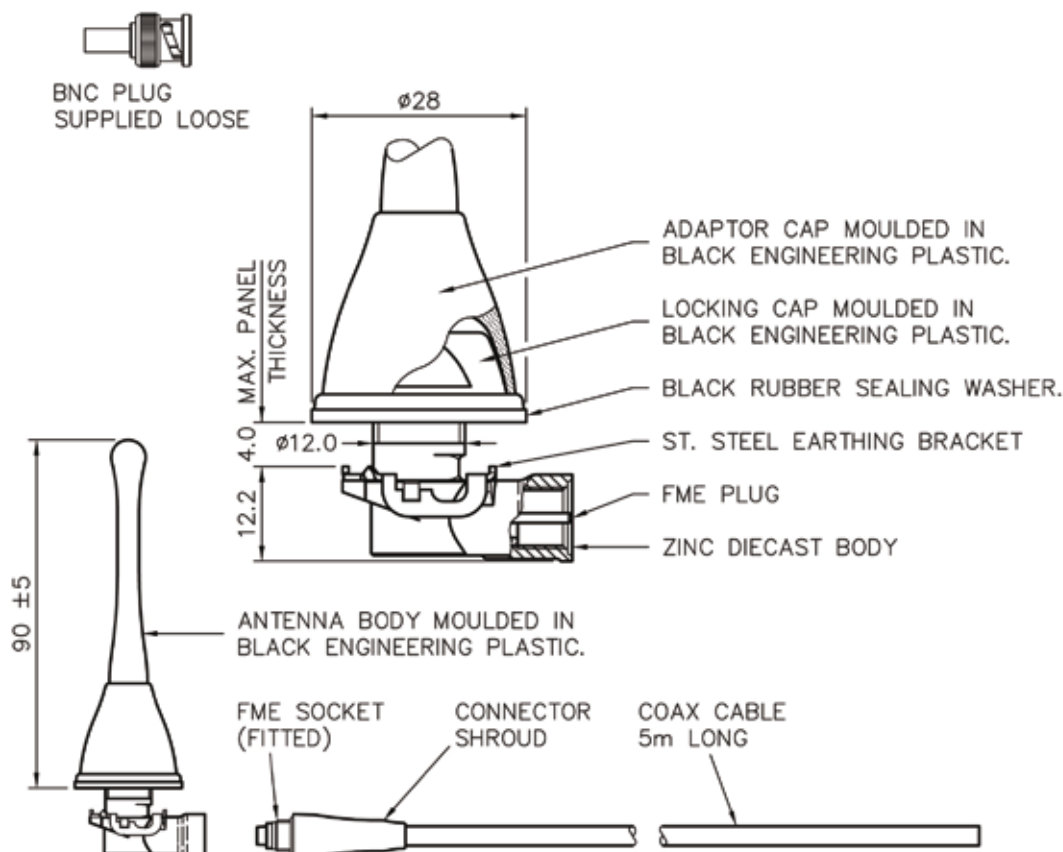

H-Plane (840MHz)

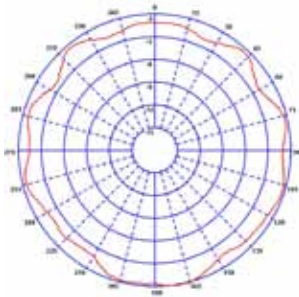

Typical VSWR

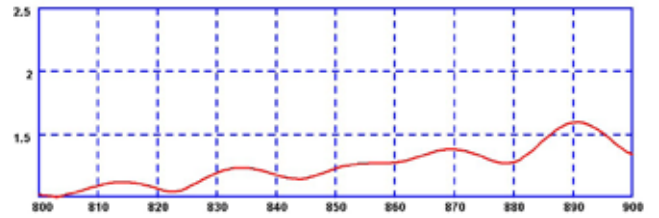

*measured on a 1m x 1m groundplane

Part No.		EBF-S5-5BL
Electrical Data		
Frequency Range (MHz)		806-870
Operational Band		S5
Gain: Isotropic		2dBi
Compared to ¼ wave		0dB
VSWR		Tx ≤ 1.5:1, Rx ≤ 2.0:1
Polarisation		Vertical
Pattern		Omni-directional
Impedance		50Ω
Max Input Power (W)		50
Mechanical Data		
Dimensions (mm)	Total height	90
	Base diameter	28
Operating Temp (°C)		-40° / +80°C
Material		Engineering plastic
Colour		Black
Mounting Data		
Fixing		Panel mount
Hole Size (mm)	Fit from outside	16
	Fit fro inside	12
Cable Data		
Type		CS23
Thickness (mm)		5
Length (m)		5
Termination		Bare end with loose BNC plug*

*Connector Configurations	
BNC (loose)	EBF-S5-5BL
TNC (loose)	EBF-S5-5TL
FME (fitted)	EBF-S5-5F
Bare End	EBF-S5-5