

LTE Magnetic Antenna

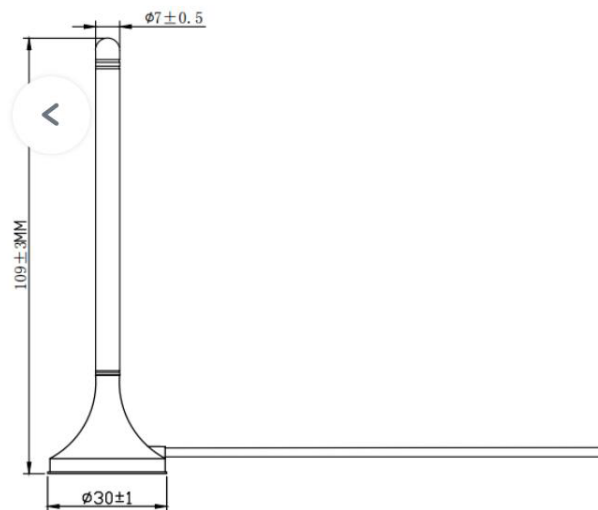

Specification

Item	Specification	
Antenna	Frequency Range	824~960/1710~2700MHz
	Polarization	Linear
	Gain	2dBi
	VSWR	<2.0
	Impedance	50Ω
Mechanical	Cable	RG174
	Cable Length	300cm
	Connector Type	SMA(m) straight
	Mounting Method	Magnet
Environmental	Operating Temperature	-40°C+85°C
	Relative Humidity	Up to 95%
	Vibration	10to 55Hz with 1.5mm amplitude 2hours
	Environmental Friendly	ROHS Complaint

Radiation pattern

1700.000MHz

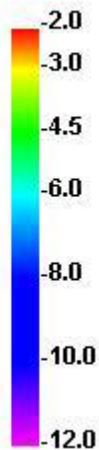
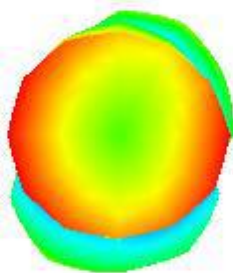

1700.000MHz H

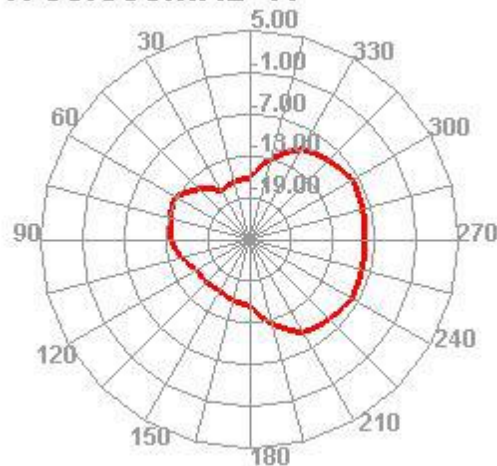

1700.000MHz E1

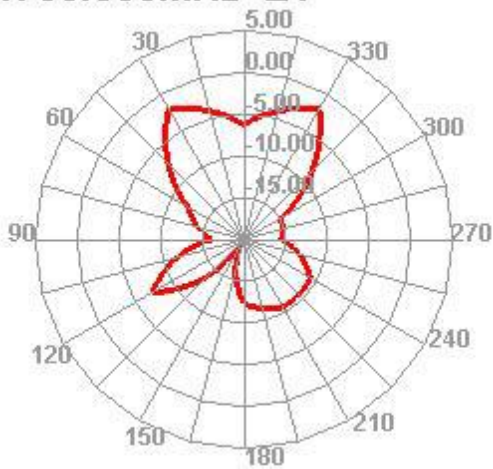

1700.000MHz E1

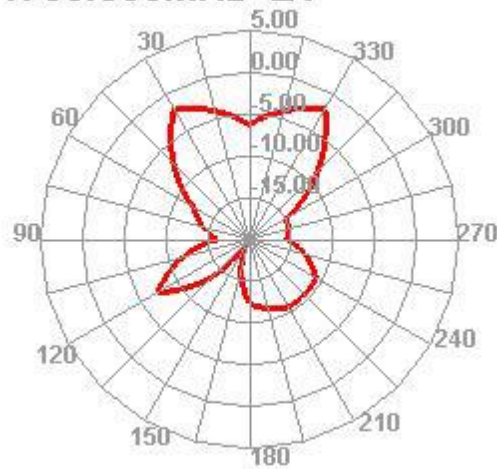

1740.000MHz

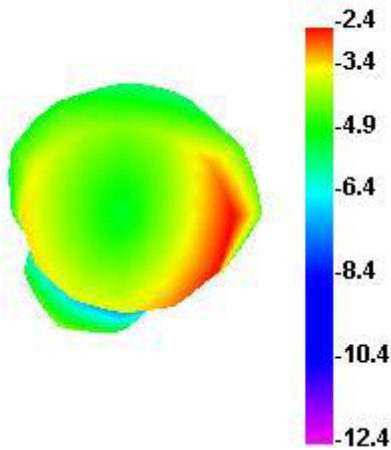

1740.000MHz H

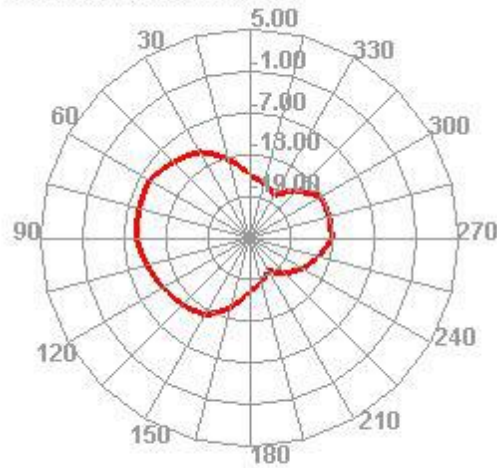

1740.000MHz H

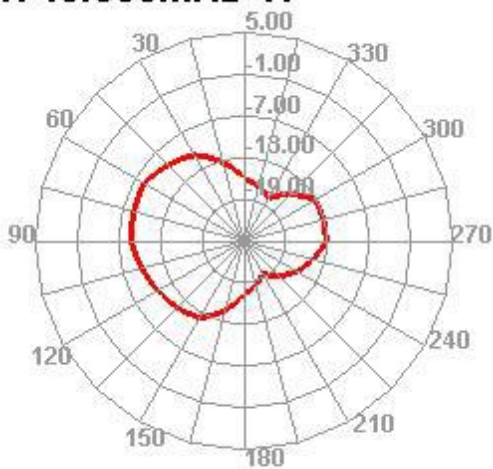

1740.000MHz E2

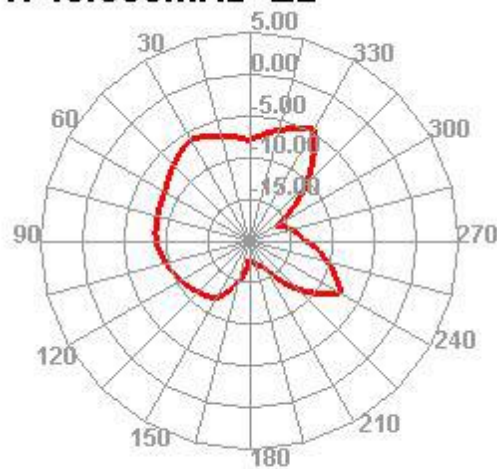

VSWR

